

Sec. 16-345-5. Surface markings

(a) All surface markings, stakes and flags indicating the approximate location of an underground facility shall be made in accordance with this section.

(b) Surface markings shall consist of paint or equivalent material. The paint or material should have sufficient lasting properties so as to stand up to wear and tear of traffic; but should be sufficiently degradable so as not to be permanent, unless the marking is intended to be permanent.

(c) Stakes shall be made of wood or any other suitable material, and flags shall be a minimum of three inches on each side of the designated utility color in accordance with subsection (i) of this section, made of any suitable material.

(d) Surface markings for the identification of the approximate location of an underground utility facility shall be located, where possible, at the centerline of the underground facility.

(e) Where center-line marking is impractical, the approximate location of an underground utility facility may be indicated by means of offset surface markings.

(f) When marking via staking or flagging, stakes and flags shall be placed in an upright position directly above the facility and:

(1) Exposed above the ground a minimum of eighteen (18) inches for stakes and a minimum of twelve (12) inches for flags; and

(2) Inserted below ground to adequately support the stake or flag in the upright position.

(g) In areas where surface markings cannot be utilized, or in areas where the use of flags or stakes would be superior to surface markings, flagging or staking shall be employed for identification of the approximate location of an underground utility facility or for designating areas of proposed excavation or demolition. Flags and stakes shall normally be located above the center line of the underground facility. Flags or stakes shall not be used for offset locations unless surface marking or center line flagging or staking is inadequate or inappropriate:

(1) In areas of grass, dirt, or other non-durable surfaces, stakes or flags shall be used unless frost conditions prevent their installation.

(2) In active construction sites where there is continual movement of equipment and supplies, stakes and flags appropriate to withstand site conditions shall be used.

(h) Surface markings, flags or stakes shall be located at the outer limits of the designated area and at such appropriate intervals, not greater than twenty (20) feet between marks, as is necessary to clearly indicate the location and course of the underground facility.

(i) With the exception of normal traffic control markings, all markings on public streets, sidewalks and rights-of-way, and all surface marking, flagging and staking of public utility locations and designated areas of excavation or demolition shall be in accordance with, and shall not conflict with, the following uniform color code:

(1) Yellow—Gas, oil petroleum products, steam, compressed air, compressed gases and all other hazardous materials except water;

(2) Red—Electric power lines, electric power conduits and other electric power facilities;

(3) Orange—Communication lines or cables, including but not limited to telephone, telegraph, fire signals, cable television, civil defense, data systems, electronic controls and other instrumentation;

(4) Blue—Water;

Regulations of Connecticut State Agencies

(5) Green—Storm and sanitary sewers and drainage systems including force mains and other non-hazardous materials;

(6) Purple— Reclaimed water, irrigation and slurry lines;

(7) White— Designated area of proposed excavation or demolition; and

(8) Pink—Survey markings.

(j) All surface marking, flagging and staking utilized for the location of underground facilities shall contain:

(1) The name of the public utility or a commonly recognized abbreviation;

(2) The material of the facility in accordance with the following (where applicable):

(A) CI – Cast Iron

(B) CU – Copper

(C) PL – Plastic

(D) ST – Steel

(E) WI – Wrought Iron

(F) RCP – Reinforced Concrete Pipe; and

(G) TD – Tile Duct; and

(3) Special descriptors of the facilities (where applicable):

(A) CDT – Conduit

(B) INS – Inserted

(C) DB – Direct buried

(D) HH – Hand hole

(E) MH – Manhole

(F) VLT – Vault.

(k) All surface marking, flagging and staking shall be in accordance with the following:

(1) Markings for pipes shall appear as follows (“ABC” (which represents the name of the public utility or commonly recognized abbreviation), pipe size, material type and any special descriptors shall also be shown in sufficient quantities to be visible from any point in the designated area):

(A) Surface marking for a run of pipe;



(B) Surface markings for a point where a pipe tees off;

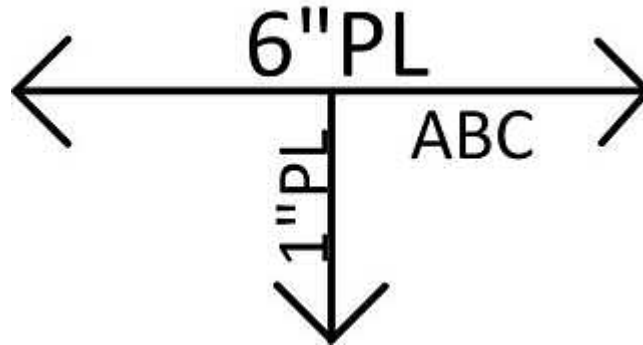

(C) Surface markings for an offset mark for run of pipe where X' represents the distance, in feet, from the reference line to the underground facility;

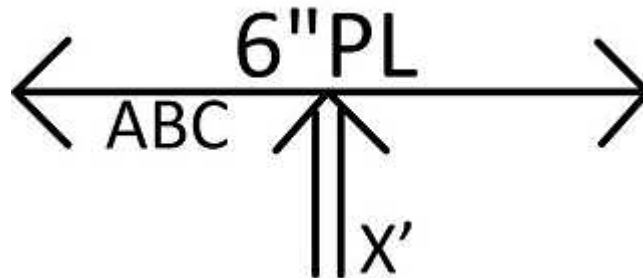

(D) Staking or flagging for a run of pipe; and

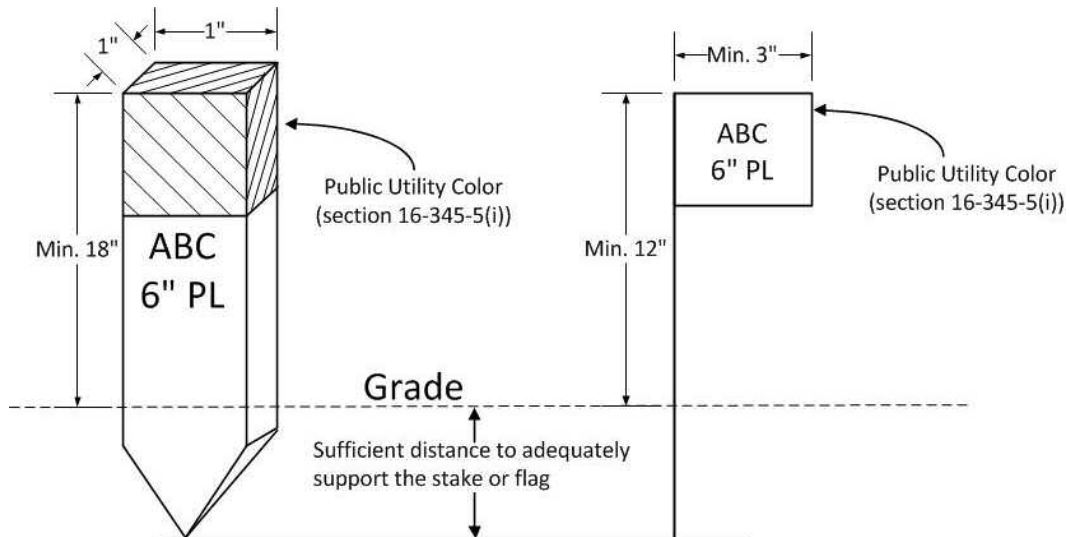

(E) Staking for an offset mark for a run of pipe where X' represents the distance, in feet, from the reference stake to the underground facility;

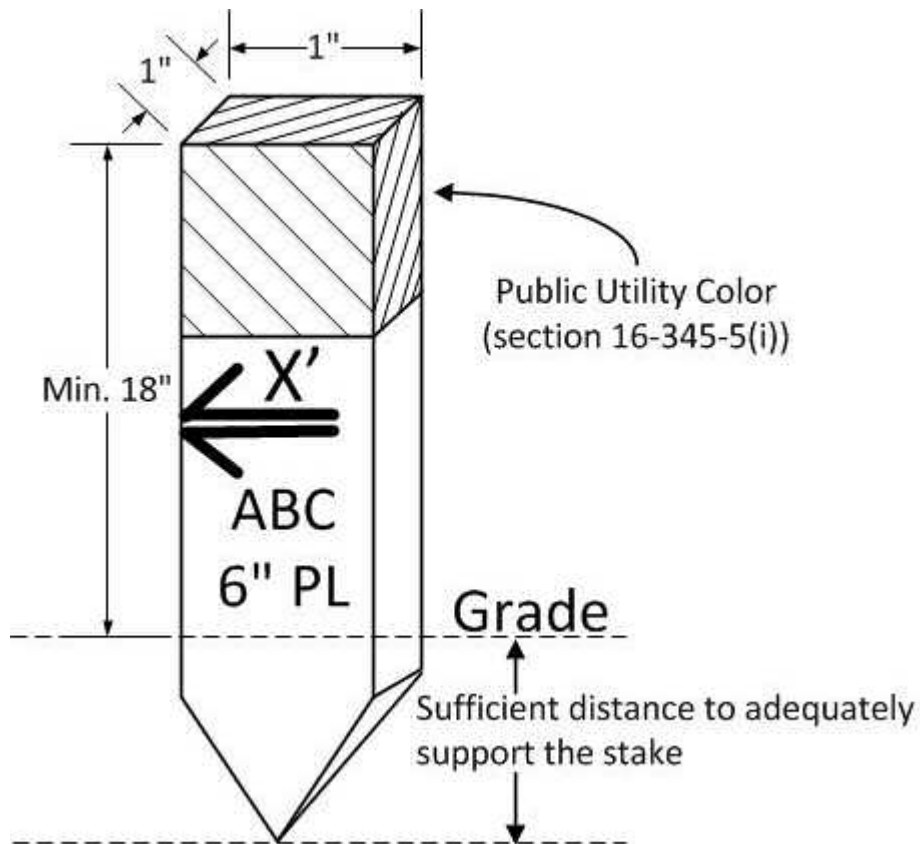

(2) Markings for cable or wire shall be as follows ("ABC" (which represents the name of the public utility or commonly recognized abbreviation) and any applicable special descriptors shall also be shown in sufficient quantities to be visible from any point in the designated area):

(A) Surface markings for a single run of cable or wire;

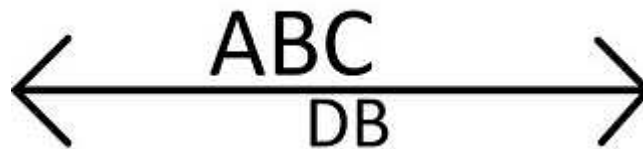

(B) Surface markings for multiple buried cables or wires;

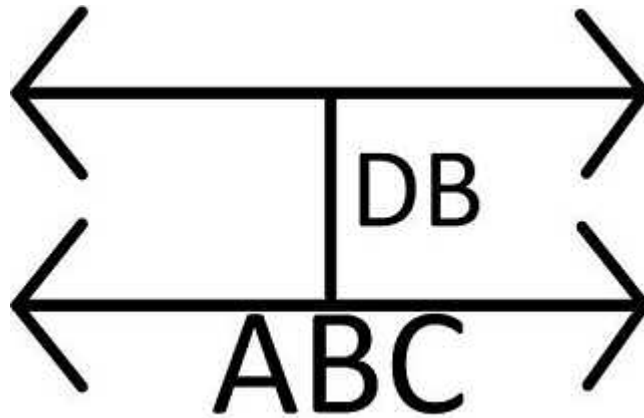

(C) Surface markings for an offset mark for single run of cable or wire where X' represents the distance, in feet, from the reference line to the underground facility;

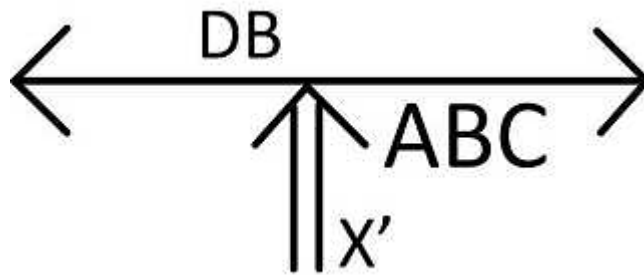

(D) Surface markings for an offset mark for multiple buried wires or cables where X' represents the distance, in feet, from the reference line to the underground facility;

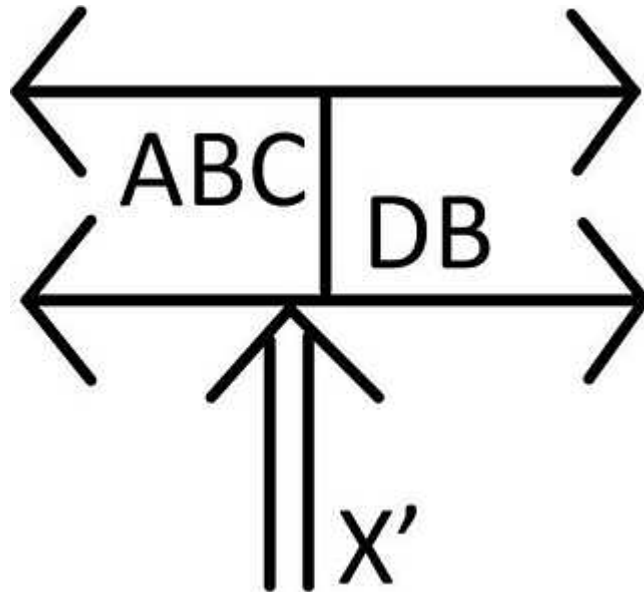

(E) Staking or flagging for cable or wire; and

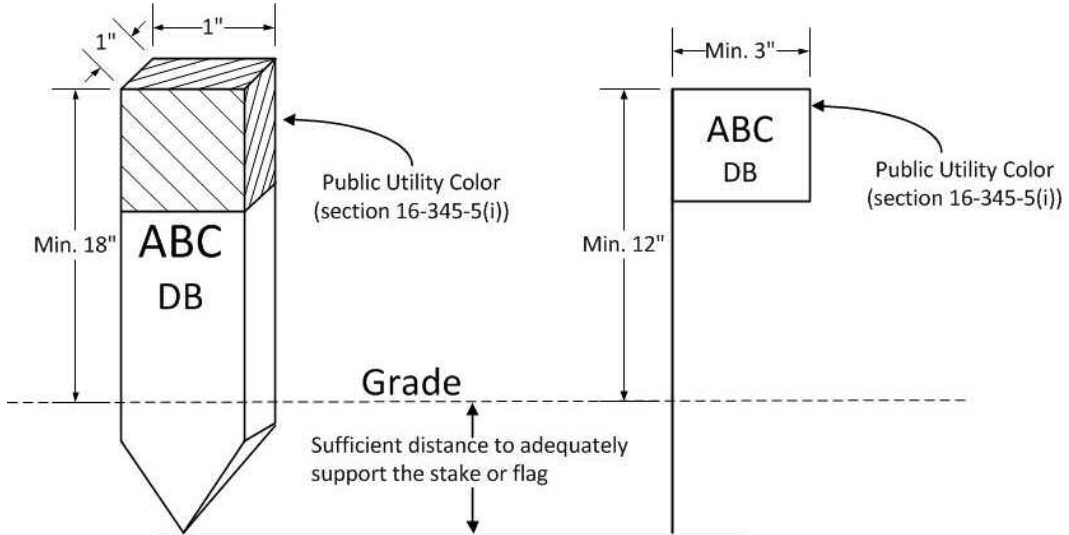

(F) Staking for an offset for cable or wire where X' represents the distance, in feet, from the reference stake to the underground facility;

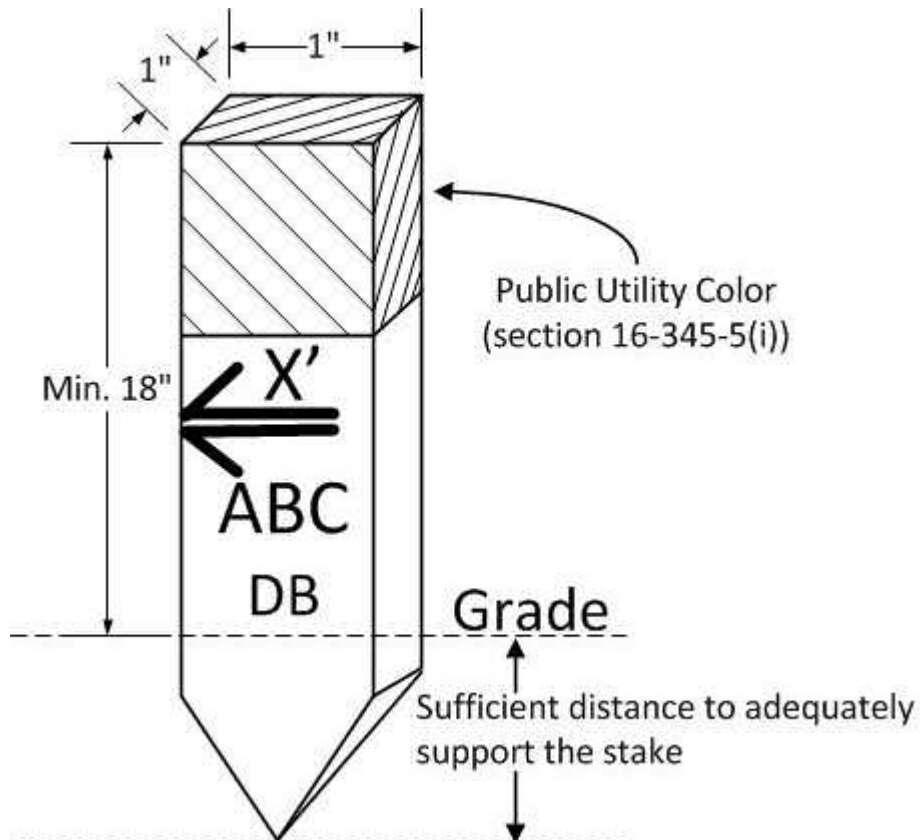

(3) Markings for a duct bank (multiple duct structure) shall be as follows ("ABC" (which

represents the name of the public utility or commonly recognized abbreviation) and any applicable special descriptors shall also be shown in sufficient quantities to be visible from any point in the designated area):

(A) Surface markings for a duct bank, where the width of the markings shall be the width of the duct bank;

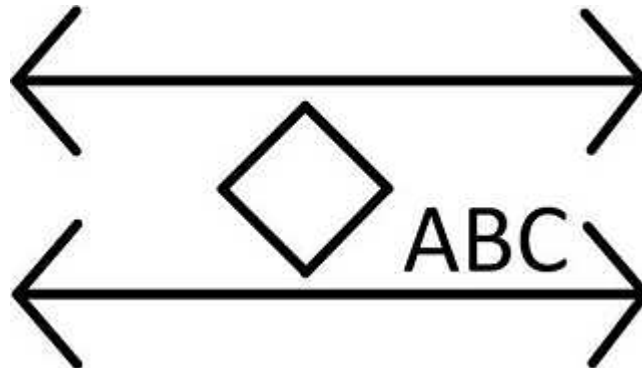

(B) Surface markings for an offset mark for a duct bank, where "X" represents the distance, in feet, from the reference line to the underground facility, and where the width of the markings shall be the width of the duct bank;

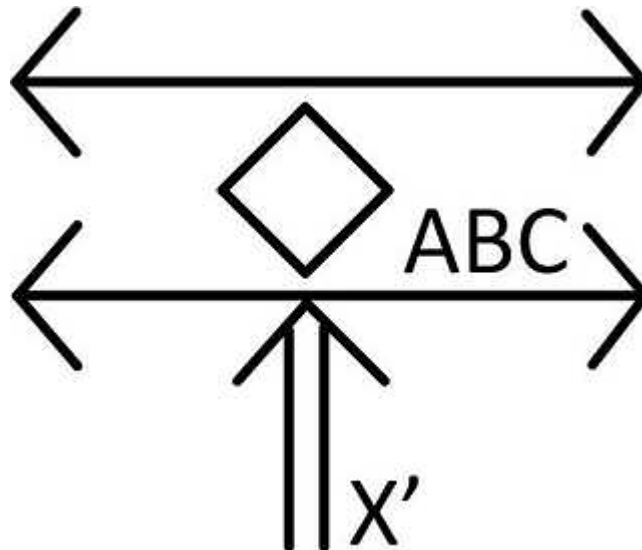

(C) Staking or flagging for a duct bank where either the diamond symbol with the width of the duct bank shall be shown (Y' represented here), or where sets of stakes or flags, without the diamond symbol, shall show the outer edges of the duct bank; and

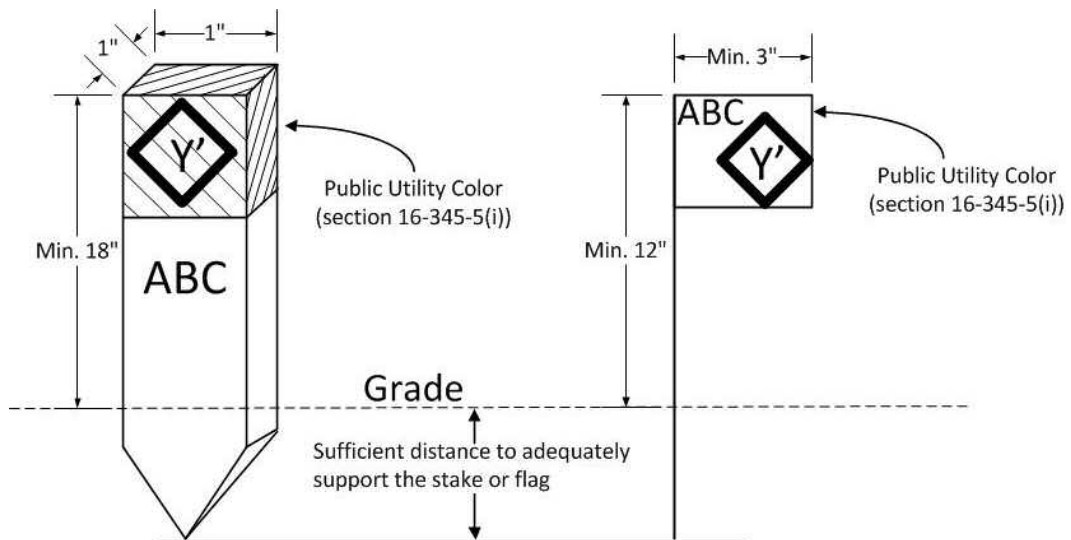

(D) Staking for an offset mark for a duct bank where X' represents the distance, in feet, from the reference stake to the centerline of the duct bank, and Y' represents the width of the duct bank;

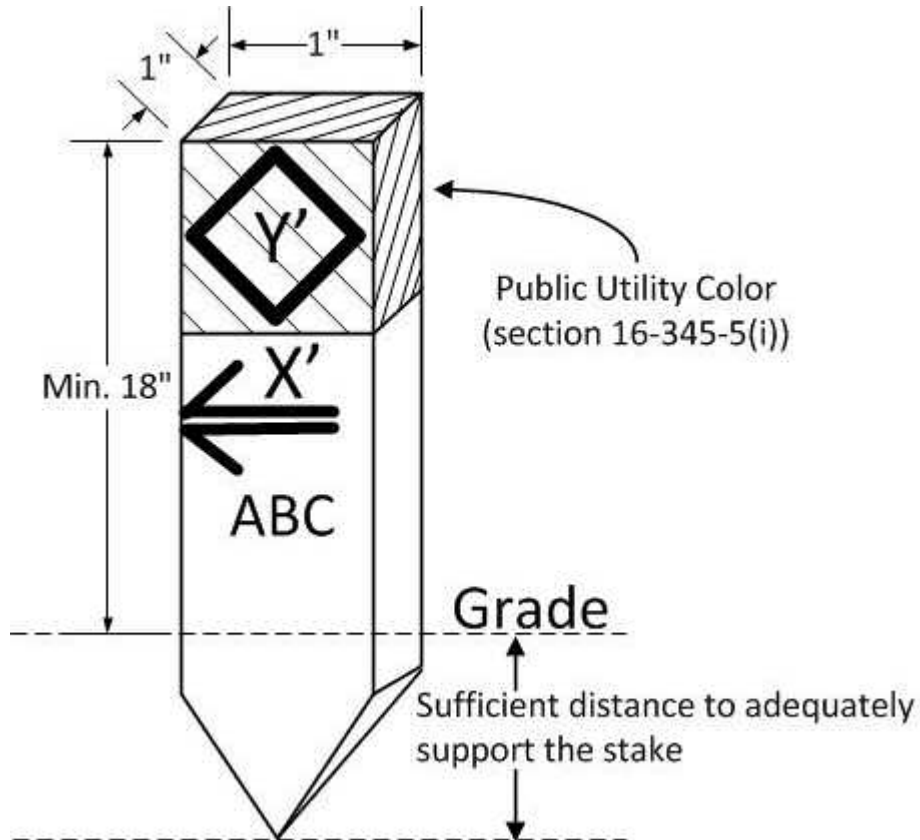

(4) Surface markings for underground structures such as manholes, vaults and handholes

shall be as follows (“ABC” represents the name of the public utility or commonly recognized abbreviation; any applicable special descriptors shall also be shown);

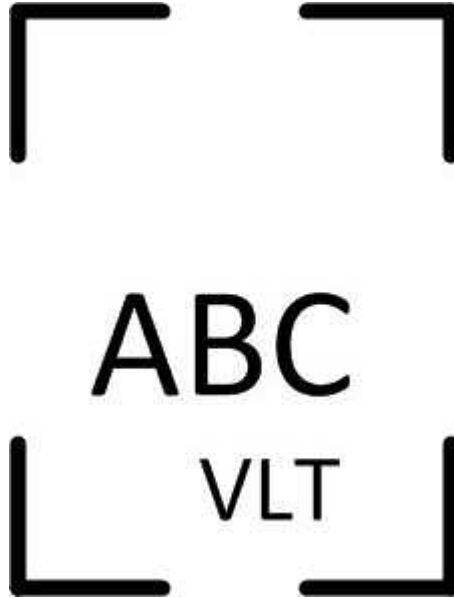

(5) Markings for special features of utility facilities shall be as follows (“ABC” represents the name of the public utility or commonly recognized abbreviation; any applicable special descriptors shall also be shown):

(A) End point of facility, such as a stub or facility that has been cut off; and

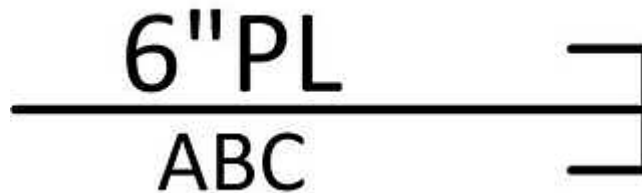

(B) Utility feature that extends to surface, such as a gas drip riser, purge riser, or blow-off.



(6) Except as provided in section 16-345-4(e)(2) of the Regulations of Connecticut State Agencies, the excavator shall identify the designated area of excavation or demolition in one of the methods as follows (“ABC” represents the name of the excavator or commonly recognized abbreviation):

(A) Surface markings consisting of brackets identifying the outer limits of the designated area;

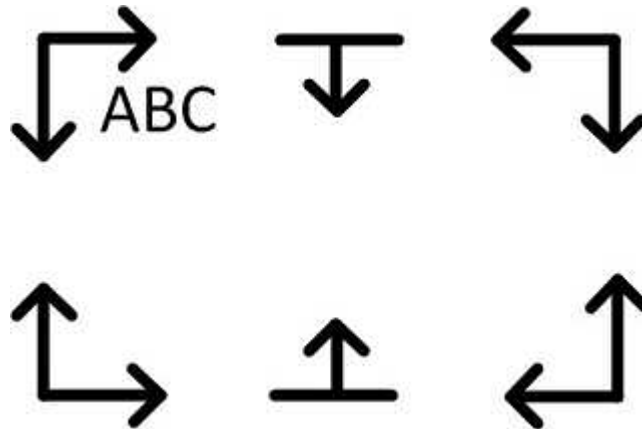

(B) Stakes or flags identifying the outer corners and boundaries of the designated area;

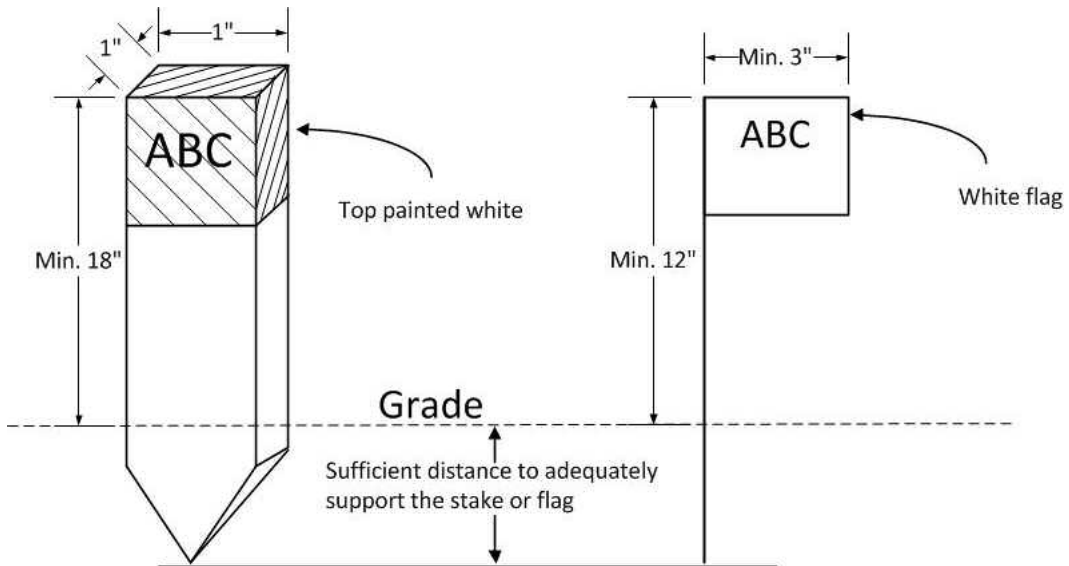

(C) A single point with a radius can be identified with the following surface marking, where X' represents the radius of the circle, in feet, around the surface marking; and

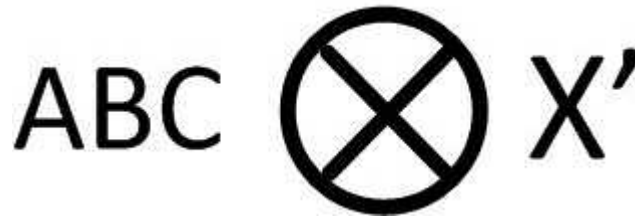

(D) A single point with a radius can be identified with a white stake or flag, where 'X' represents the radius of the circle, in feet, around the stake or flag.

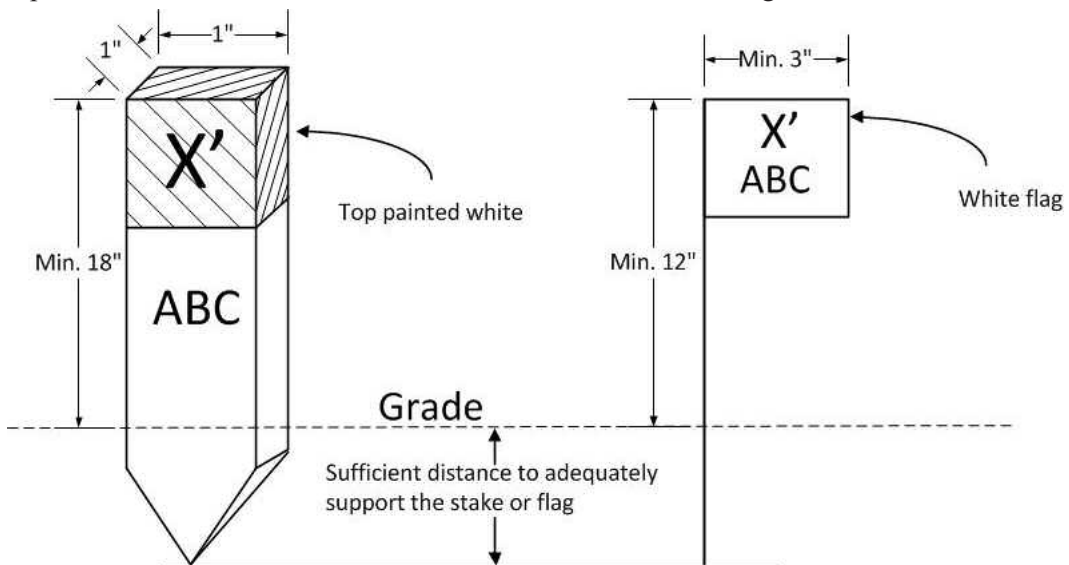

Regulations of Connecticut State Agencies

(l) A public utility may, in accordance with the provisions of subsection (c) of section 16-345-3 of the Regulations of Connecticut State Agencies, identify the approximate location of a facility connected to its facility beyond the point of the interconnection or tee, but not owned or operated by the public utility as a helpful guide to an excavator in a similar manner to subsections (a) to (j), inclusive, of this section, except that surface markings shall be dotted or broken line instead of a solid line.

(m) A public utility may signify that it has no facilities in the designated area by writing “NO” plus the name of the public utility or commonly recognized abbreviation in letters at least six inches high using the uniform color code as described in subsection (i) of this section.

(Effective October 25, 1988; Amended March 21, 1997; Amended August 23, 2000; Amended August 2, 2016)